

Data Sheet



Article number: 5863503814

Description: Ball Valve 350.3814, G 1 1/2" - G 1 1/2"
Thread/Thread

Measures

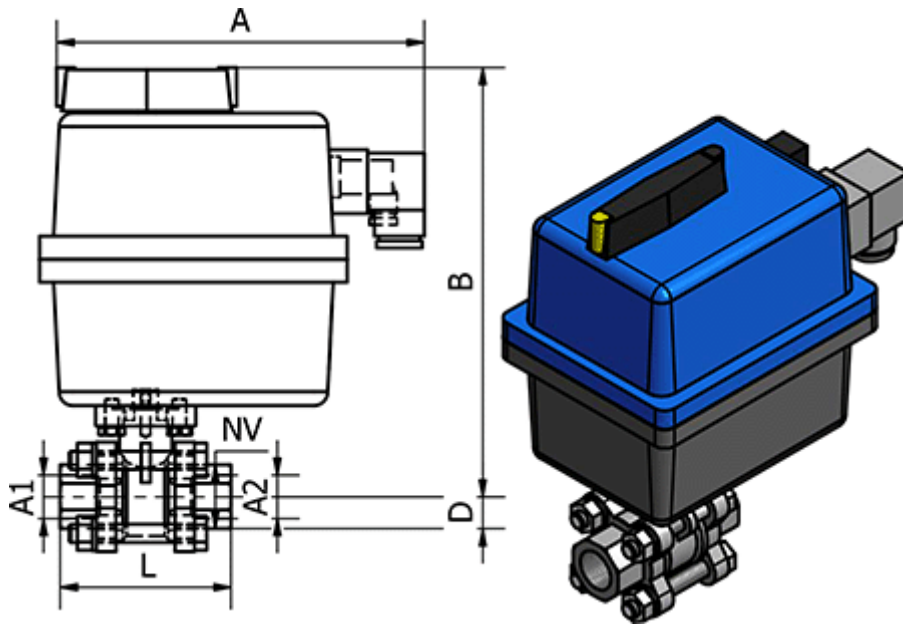

= -	Connecting A2	= G 1 1/2"
= -	D	= 40
= -	L	= 104
= -	Max. Operating Pressure	= 25 bar
= -	NV	= 58

A = 177
B = 211
Connecting A1 = G 1 1/2"